

GHG-MA95A Multi Angle Locking Hinge

Features

- Easily adjusts the flap angle by toggling the lever
- Lock allows the hinge to be held in position from 0° to 180° in 10° increments
- Flap is temporarily unlocked while the lever is pushed
- Flap stays unlocked when the lever is lifted
- Both hinge types can be used together

Recommended Screws

- M5 screw

Two Ways to Unlock

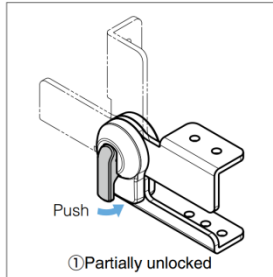

The flap is temporarily unlocked while the lever is pushed.

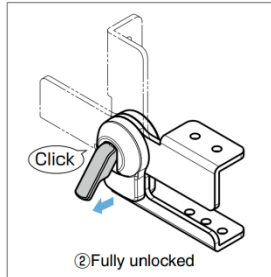

The flap stays unlocked when the lever is lifted.

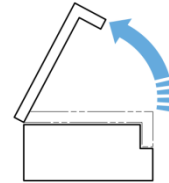

Holds in position at angles in 10° increments

Locus Chart

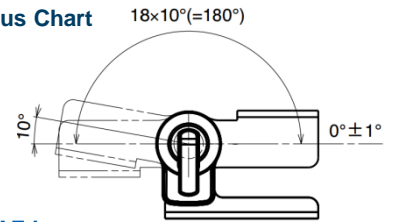

GHG-MA95A-L

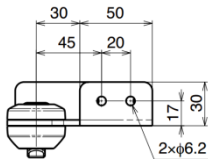

GHG-MA95AF-L

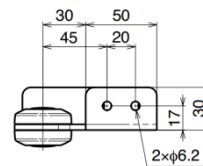

Rotation Angle 188°

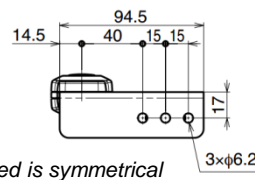
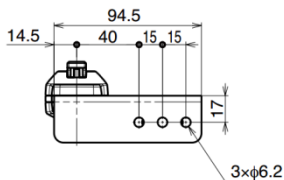
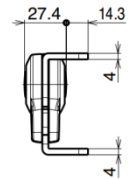
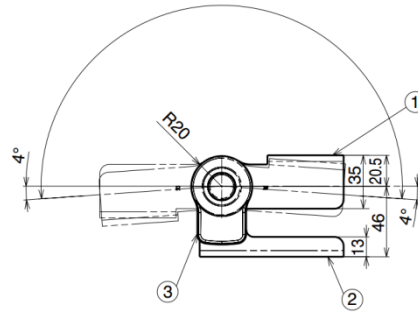
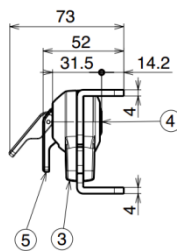
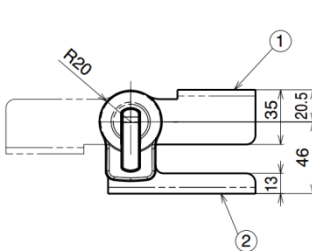

Left-handed shown. Right-handed is symmetrical

No.	Part Name	Material	Surface Finish
①	Bracket	Steel	Nickel
②	Base	Steel	Nickel
③	Plastic Cover	PC	-
④	Pin	ABS	-
⑤	Lever	PA	-

Part No.	Position	Type	Max. Torque (per piece)	
GHG-MA95A-R	Right-handed	With Lever	45 N.m	459 kgf.cm
GHG-MA95A-L	Left-handed			
GHG-MA95AF-R	Right-handed	Without Lever	-	-
GHG-MA95AF-L	Left-handed			